

LedSync820C LED Video Processor

USER'S MANUAL

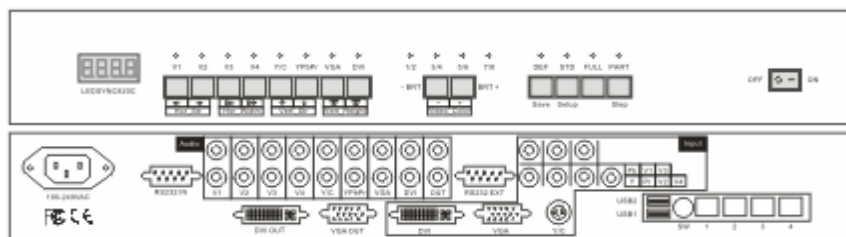

TABLE OF CONTENTS

I. Safety precautions	3
II. Connections of hardware	
1. Rear view	4
2. Port description	4
3. Connectivity Diagram of hardware.....	6
III. Frontal panel operations	
1. Diagram of frontal panel.....	7
2. Button operations	7
3. Software control.....	8
IV. Output image setup	
1. LedSync820C output image.....	9
2. Setup LedSync820C output image	10
V. Troubleshooting	12
VI. Specifications	15

I. Safety Precautions

Danger!

There is high voltage in the processor, to prevent any unexpected hazard, unless you are a maintenance, please do not open the cover of the device.

Warning!

1. This device shall not encounter water sprinkle or splash, please do not place anything containing water on this device.
2. To prevent fire, keep this device far from any fire source.
3. To keep good ventilation, there shall be at least 20cm interval between frontal and rear panel of the device.
4. If this device gives out any strange noise, smoke or smell, please immediately unplug the power cord from receptacle, and contact local dealer.
5. **Please do not plug or unplug DVI signal cable when the device on power.**

Caution!

1. Please thoroughly read this manual before using this device, and keep it well for future reference.
2. In the event of lighting or when you are not going to use the device for a long time, please pull the power plug out of receptacle.
3. Nobody other than professional technicians can operate the device, unless they have been appropriately trained or under guidance of technicians.
4. To prevent equipment damage or electric shock, please don't fill in anything in the vent of the device.
5. Do not place the device near any water source or anywhere damp.
6. Do not place the device near any radiator or anywhere under high temperature.
7. To prevent rupture or damage of power cords, please handle and keep them properly.
8. Please immediately unplug power cord and have the device repaired, when
 - 1) Liquid splashes to the device.
 - 2) The device is dropped down or cabinet is damaged.
 - 3) Obvious malpractice is found or performance degrades.

II. Connections of hardware

1. Rear view

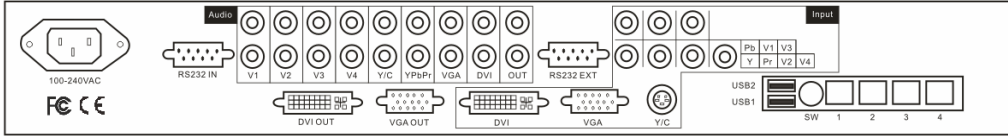

Figure 1

2. Port description

1) Video input (**INPUT** column)

LedSync820C supports 8-channel signal input, including:

Port name	Description
V1~V4	4-channel PAL/NTSC system composite video input
Y/C (S_Video)	1-channel PAL/NTSC system S_Video input
VGA	1-channel computer analog signal input
DVI	1-channel computer digital signal input
YPbPr	1-channel high-definition component signal input

2) **Audio** input

Corresponding to 8-channel video input signal, **LedSync820C** supports 8-channel stereo audio signal input

3) Video signal output

Port name	Description
VGA OUT	1-channel analog RGBHV signal output, it can be connected to a local display device and used as monitor (it is strongly recommended to use this port when operating and setting LedSync820C).
DVI OUT (1)	1-channel digital DVI signal external output, it is to be connected with external LED transmission card or LED transmission box
DVI OUT (2)	1-channel digital DVI signal internal output, it is to be connected with internal LED transmission card.

4) Audio signal output

It corresponds to the selected video input signal, and output this channel audio input signals.

5) Signals of other ports

Port name	Description	
RS232 IN	Serial communication port, LedSync820C 's Timing Control Software running on Upper Controller can operate and control LedSync820C via this communication port.	
RS232 EXT	Reserved port, if LedSync820C has built-in LED transmission card and this card has RS232 control port, RS232 EXT port can bridge RS232 control port of LED transmission card to outside of LedSync820C case.	
USB 1	Reserved port.	
USB 2	Reserved port, if LedSync820C has built-in LED transmission card and this card has USB control port, USB2 port can bridge USB control port of LED transmission card to outside of LedSync820C case.	
RJ45 port (1, 2, 3, 4)	Reserved port, if LedSync820C has built-in LED transmission card and this card transfers signals via RJ45 port, RJ45 port (1, 2, 3, 4) can bridge RJ45 port of LED transmission card to outside of LedSync820C case.	
RJ45 port (4)	Reserved port, if LedSync820C has built-in TCP/IP Ethernet communication module, RJ45 port (4) can bridge RJ45 port of built-in TCP/IP Ethernet communication module to outside of LedSync820C case.	
SW	Eject out	Select RS232 mode to operate and control LedSync820C , use RS232 IN port as communication port.
	Press-in	Select TCP/IP mode to operate and control LedSync820C , use RJ45 port (4) port as communication port.

3. Connectivity Diagram of hardware:

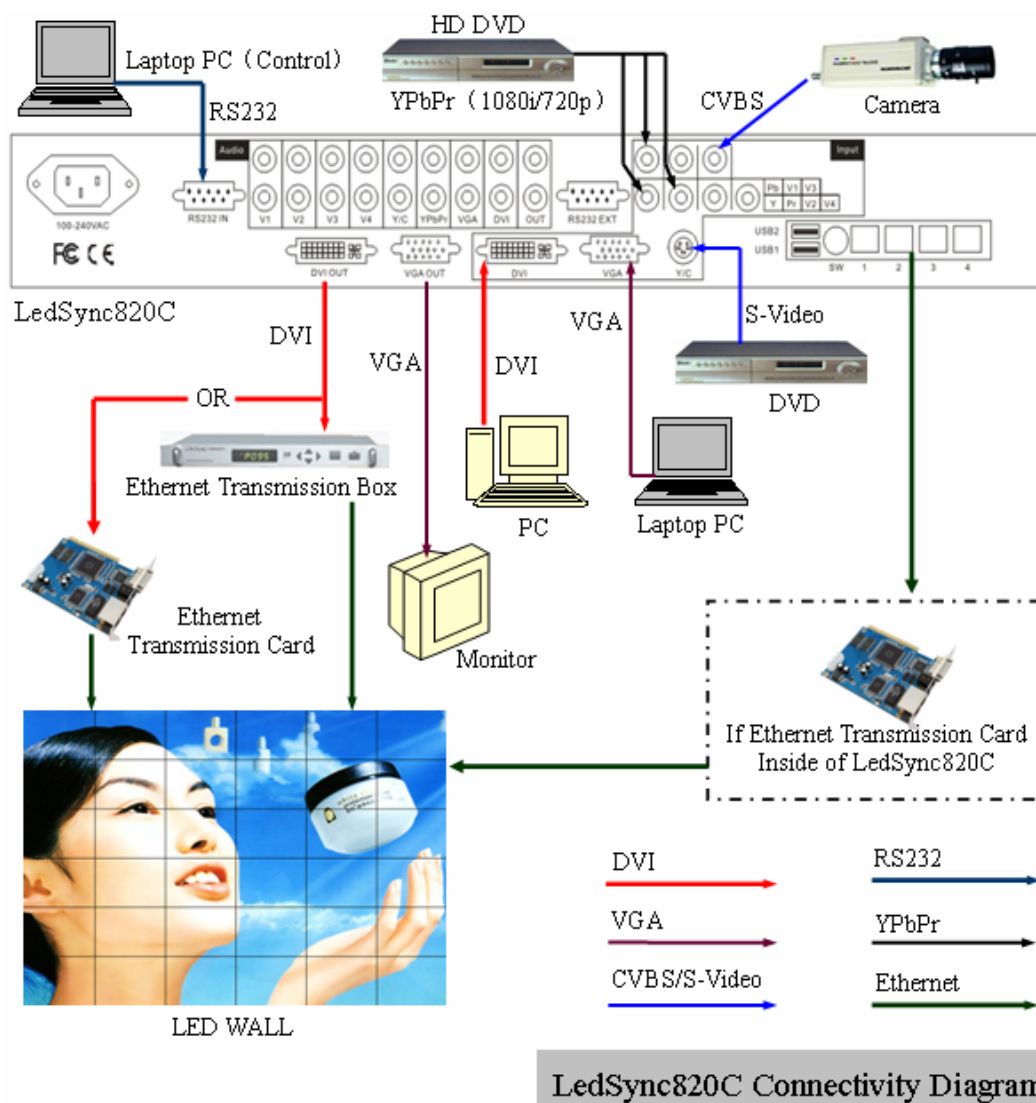

Figure 2

LedSync820C Connectivity Diagram

III. Frontal panel operations

1. Diagram of frontal panel

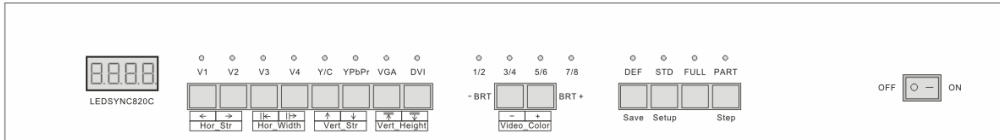

Figure 3

2. Button operations:

LedSync820C have 14 buttons on frontal panel, after start-up all these buttons are in operation mode. Their functions are described as below:

1) Select input video source

Button names	Description
V1~V4	Switch to V1~V4, composite video input
Y/C (S_Video)	Switch to S-Video input
VGA	Switch to computer analog signal input <i>Note: to get clarity computer image, you can click the “VGA” button 6 times continuously, and then you can click “VGA” button again and again to change the computer image sampling phase, when the computer image be displayed most clearly, the adjustment is ok.</i>
DVI	Switch to computer digital signal input
YPbPr	Switch to high-definition component video signal input <i>Note: to get clarity HDTV image, you can click the “YPbPr” button 6 times continuously, and then you can click “YPbPr” button again and again to change the HDTV image sampling phase, when the HDTV image be displayed most clearly, the adjustment is ok.</i>

Switch audio input while operating above buttons, select the audio signal input from corresponding video input to output it through **Audio OUT**.

Notes: when user has selected input signal, if there are signal input in corresponding signal input ports and are in **LedSync820C** formats, the indicator above corresponding button will be illumed. However, when there are no signal input in corresponding input ports, the indicator above corresponding button will blink, and dark screen will be displayed on the screen.

2) Select output brightness

Button names	Description
BRT -	Decrease output image brightness of LedSync820C
BRT +	Increase output image brightness of LedSync820C

LedSync820C supports 8 levels Brightness, "1" represents the lowest brightness, 8 represents the highest brightness. When brightness is adjusted to be "1", "3", "5" or "7", their LED indicators will blink; When brightness is adjusted to be "1", "3", "5" or "7", their LED indicators will keep illumed.

3) Select image status

Button names	Description
DEF	Select user-defined image parameters, including GAMMA value, Video Chrom and Hue. User can define custom parameters using PC software.
STD	Select a standard image status to output image. This standard image has been preset at factory, including GAMMA =1, Video Chrom and Video Hue = standard values. User can't modify these standard values.

4) Select FULL/PART display (FULL, PART)

Button names	Description
FULL	FULL means that LED will display a full picture.
PART	PART means that LED only display a part of a picture.

3、 Software Control:

LedSync820C is supplied with Timing Control software  **LedSync.exe**, user can operate and control LedSync820C using this software, including:

- Switch input signal source, change brightness of output images.
- Manually operate and control it or edit operation and control schedule to make it executed automatically.
- Carry out site control, or remote control over **LAN** or **WAN**.

For details please refer to **LedSync82xx Timer**.

IV. Setup of output image

The following setups must be made by relevant qualified technicians. For ordinary users, unless they have received adequate relevant training, they shall not attempt the following setup operations!

1. LedSync820C output image

LedSync820C output images from VGA OUT and DVI OUT in the format: 1024 × 768 pixels, with refresh frequency of 60Hz.

However, the resolution of LED screen is not exactly 1024 × 768 pixels. When the resolution of LED screen is less than 1024 × 768 pixels, we can set **LedSync820C** to output the images exactly fitting the resolution of LED screen, so that the LED could display a full frame of image. See the schematic diagram below:

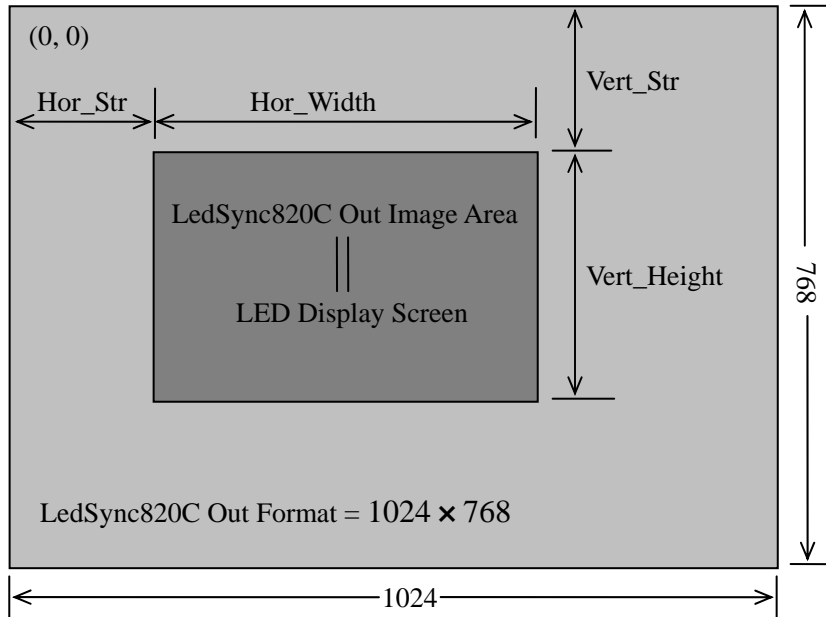

Figure 4









As above figure shows: the size and location of **LedSync820C** output images are defined by 4 groups of parameters:

Name	Description
Hor_Str	The horizontal start position of output image
Hor_Width	The horizontal width of output image
Vert_Str	The vertical start position of output image
Vert_Height	The vertical height of output image

The start coordinates (0, 0) of sync820C output image is defined in the right top of 1024 × 768 pixels output area.

2. Setup of LedSync820C output image

LedSync820C can setup its output image by operating the buttons on frontal panel. After **LedSync820C** is started up, all buttons on frontal panel are in operation mode. As above section **III.2** describes, if you press “**STD**” button for continuous 18 times, **LedSync820C** will enter setup state, and all buttons on frontal panel are ready to be in setup mode. See the table below for the definitions of each button:

Name		Description	
Hor_Str		Move output image leftward.	
		Move output image rightward.	
Hor_Width		Decrease width of output image	
		Increase width of output image	
Vert_Str		Move output image upward.	
		Move output image downward.	
Vert_Height		Decrease height of output image	
		Increase height of output image	
Video_Color	-	Decrease video color	Standard color value=0. -16 represents the lowest color, +16 represents the highest color
	+	Increase video color	
Save		Save currently adjusted values	
Setup		Press the button for continuous 18 times, LedSync820C will enter setup state, press it again, LedSync820C will exit setup state and enter operation state.	
Step		Select step value 1 or 10	

Notes:

- a) Generally **Hor_Str 0**. If you need modify it, the value of **Hor_Str** can be setup to be - 8 ;
- b) Generally **Vert_Str 0**. If you need modify it, the value of **Vert_Str** can be setup to be - 5 ;

- c) Generally, the start coordinates of output image (**Hor_Str** , **Vert_Str**) should be identical to the start coordinates of the input image that LED transmission card captured;
- d) The resolution of output image can be adjusted to the lowest 8 × 8 pixels;
- e) The output image shall not exceed the output area of 1024 × 768 pixels;
- f) While the current video image of **LedSync820C** is valid image, the video color can be adjusted;
- g) The custom video color is only accessible by pressing “**DEF**” button while in operation mode;
- h) If there are no valid input signals in **LedSync820C**, when it enters setup mode, a green screen will be generated as reference image;
- i) It is strongly recommended to connect a VGA monitor to **VGA OUT** of **LedSync820C**, so as to intuitively display all above adjustment and setups.

V. Troubleshooting

1、 Dark screen, no image on LED

Check the input source of **LedSync820C** for any abnormality. If the indicator above input signal button is illumed, it means the input source is in good condition; however, if the indicator blinks, it means some fault has occurred.

If the input source is normal, the indicator will keep illumed.

Press "**PART**" button on frontal panel of **LedSync820C**. While in **PART** mode, LED will display image; however, while in **FULL** mode, LED will display dark screen; the moment please check whether the start coordinates of **LedSync820C** output image is identical to the start coordinates of the input image that LED transmission card captured.

No image display even in **PART** mode, connect 1 VGA monitor to **VGA OUT** of **LedSync820C**, check whether there are images appearing on VGA monitor.

[If there are images on VGA monitor, please check:](#)

The DVI connection between DVI output of **LedSync820C** and DVI input of LED transmission card

Each section of Ethernet cable connection between LED transmission card and LED screen. **The signal has been weakened a lot and imposed high risk of interference from outside after long-term transmission passing many sections of Ethernet cable. Please adopt high-quality Ethernet cable and RJ45 connector, and shorten the Ethernet cable to the most extent.**

Hot swap of DVI cable may result in burning of DVI drive or receiving chips.

[If there are no images on VGA monitor, please have supplier repair it](#)

If the input source is abnormal, the indicator will keep blink.

[If current input source is: DVI](#)

First, check DVI connection cable

Actuate DVI output of PC graphic display card

	<p>Set the output resolution any of the following 800 × 600 1024 × 768 1280 × 1024 Note that DVI output refresh frequency (Vertical Scanning Frequency) must be: 60Hz If DVI indicator of LedSync820C frontal panel still blinks, please have supplier repair it.</p>
	<p>If current input source is: VGA</p>
	<p>First, check VGA connection cable Actuate VGA output of PC graphic display card Set the output definition any of the following 800 × 600 1024 × 768 1280 × 1024 Note that VGA output refresh frequency (Vertical Scanning Frequency) must be: 60Hz If VGA indicator of LedSync820C frontal panel still blinks, please have supplier repair it.</p>
	<p>If current input source is: YPbPr</p>
	<p>First, check YPbPr cable, the three cables Y, Pb, Pr are connected to corresponding input jacks of LedSync820C respectively. Make sure YPbPr signal is in any of the following formats: 720p@60Hz 1080i@60Hz If the YPbPr indicator on frontal panel of LedSync820C still blinks, please have supplier repair it.</p>
	<p>If current input source is: Y/C(S_Video)</p>
	<p>Check S_Video cable. Make sure S_Video output of DVD player has been actuated (some DVD players might have disabled S_Video output, it must be reset and actuated). If Y/C indicator on frontal panel of LedSync820C still blinks, please have supplier repair it</p>

2、 Timing Control software  LedSync.exe can't control LedSync820C

- 1) Make sure RS232 cable supplied with the machine is properly connected, one end connects **COM** port of PC, the other end connects **RS232 IN** of **LedSync820C**;
- 2) Eject **SW** button on the rear of **LedSync820C** case, select the RS232 communication mode through **COM** port of PC;
- 3) Identify the No. of the PC's COM port to be connected, e.g. COM1 or COM2, select appropriate COM port on  control software;
- 4) Select appropriate COM port, and ensure this COM port not yet occupied by other applications, e.g. the common **LedStudio** software;
- 5) If after the above steps **LedSync820C** still can't be controlled, please have supplier repair it.

3、 When the Ethernet cable is directly connected to the RJ45 port of built-in LED transmission card, there are images appearing on LED screen; however, when it is connected via internal **RJ45 Bridge Module** of LedSync820C, there are no images appearing on LED screen

- 1) Make sure internal **RJ45 Bridge Module** of **LedSync820C** is properly connected;
- 2) Make sure the 8 wires of internal short Ethernet cable of **LedSync820C** are in correct sequence, and the 8 wires are connected to **RJ45** connector in both ends in sequence, and are free of cross. See the figure below:

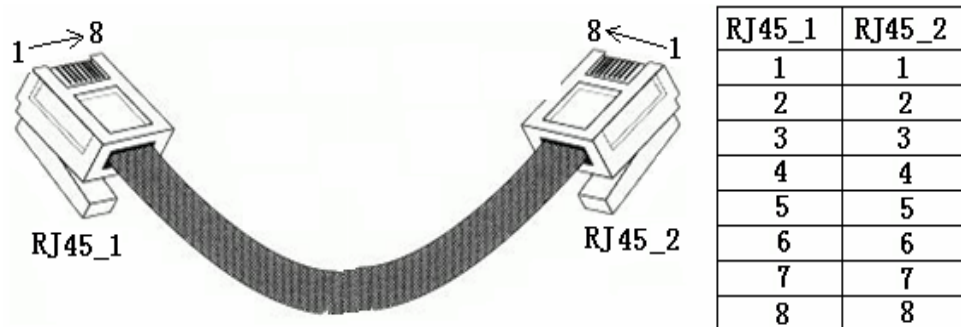

Figure 5

- 3) The image transfer from LED transmission card to LED display screen is made through Ethernet cable. The signal has been weakened a lot and imposed high risk of interference from outside

after long-term transmission passing many sections of Ethernet cable. Please adopt high-quality Ethernet cable and RJ45 connector, and shorten the Ethernet cable to the most extent

VI. Specifications

Inputs	
Nums/Type	1 × RGBHV(VGA) 1 × DVI 1 × YPbPr(HDTV) 4 × CVBS 1 × Y/C(S-Video)
Video system	PAL/NTSC
CVBS Scope/Impedance	1V (p_p) / 75
Y/C Scope/Impedance	Y: 0.7V (p_p) / 75 , C: 0.35V (p_p) / 75
RGB/DVI resolution	1280 × 1024@60Hz, 1024 × 768@60Hz , 800 × 600@60Hz
RGB Scope/Impedance	0.7 V (p_p) / 75
YPbPr (HDTV) System	1280 × 720p@60Hz, 1920 × 1080i@60Hz
YPbPr (HDTV) Scope/Impedance	Y: -0.3V ~ +0.7V (p_p) / 75 Pb: -0.35V ~ +0.35V (p_p) / 75 Pr: -0.35V ~ +0.35V (p_p) / 75
Connectors	RGBHV: 15pin D_Sub(female) DVI: 24+1 DVI_D YPbPr(HDTV): RCA × 3 CVBS: RCA Y/C: 4pin mini DIN(female)
Outputs	
Nums/Type	1 × RGBHV 1 × DVI
RGB/DVI resolution	1024 × 768@60Hz
RGB Scope/Impedance	0.7 V (p_p) / 75
Connectors	RGBHV: 15pin D_Sub(female) DVI: 24+1 DVI_D
Others	
Control	RS 232. Panel Button
Power	100-240VAC 60W 50/60Hz
Operating Temp	5-40
Humidity	15-85%
Size	155 mm (high) × 350mm (wide) × 485mm (length)
Weight	5.6 Kg